



# 18 Cell-33 Plate (With or without cover) Tray Size: 44.75" x 38.33"

Rev.3 11-27-2013

EZF-18337

## EZ Fill

Please follow the drawing precisely as shown.

Note: Remove battery caps, lay string of valves on battery as shown in the diagram below. Snap each valve into the corresponding cell. Make sure all tubing remains unobstructed. Always water battery after charging is complete.

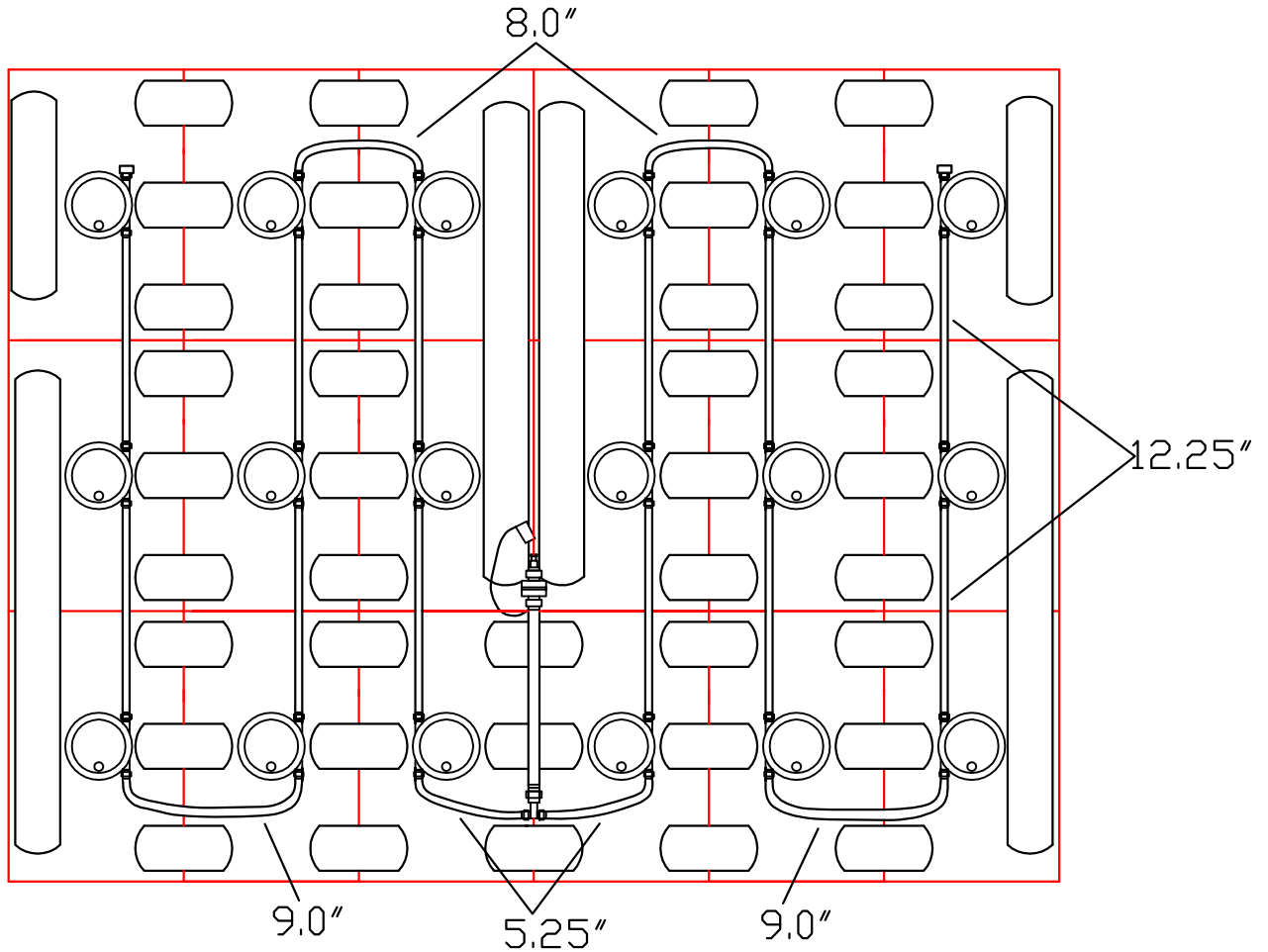

Part #	Description	Quantity
VARIOUS	Low Profile Valve	18
BWT-08TUB6BLK	6mm Tubing	17 ft.
BWT-08T666N	6-6-6 T Piece	1
BWT-09BDCAP	Dust cap	1
BWT-09MBLU1	¼ Male connector	1
BWT-08CAP6	End cap	2